

Outline

- 1 CCD Review
- 2 CMOS and CMOS Hybrid Detectors
- 3 Array Detector Properties
- 4 Array Detector Data Reduction
- 5 Array Detector Problems



hubblesite.org

Charge Coupled Device (CCD)

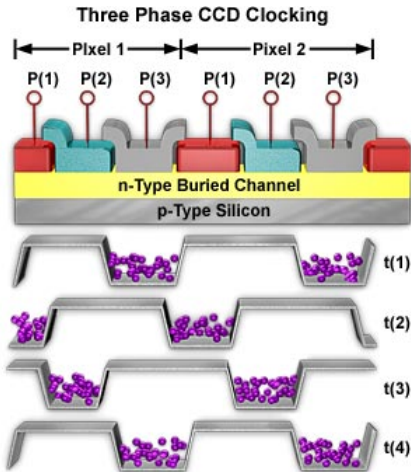

Figure 1

imagingu.com/articles/threephase.html

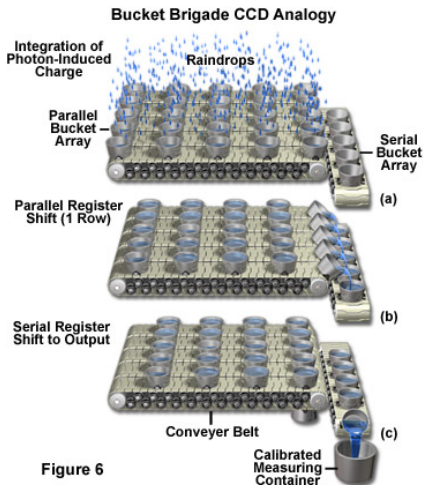

Figure 6

imagingu.com/articles/microscopyimaging.html

CCD Readout Architectures

Common Charge-Coupled Device (CCD) Architectures

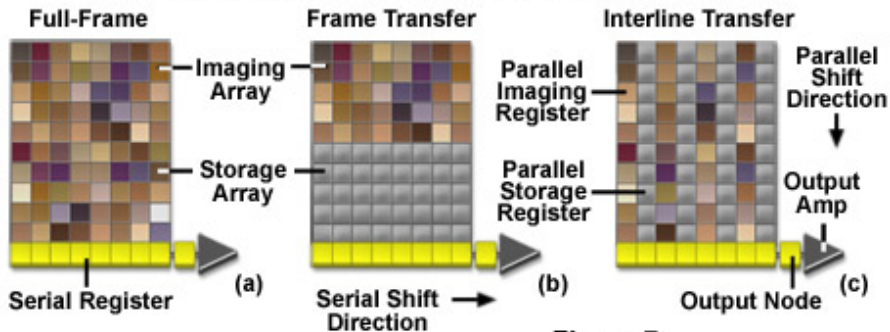

Figure 7

imagingu.com/articles/microscopyimaging.html

2 x 2 Pixel Binning Read-Out Stages

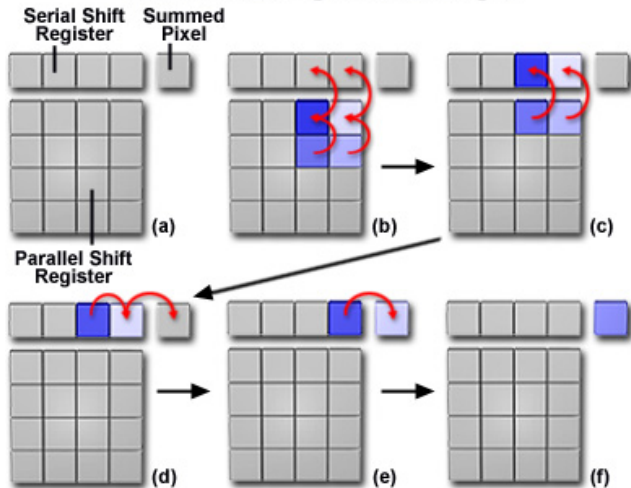
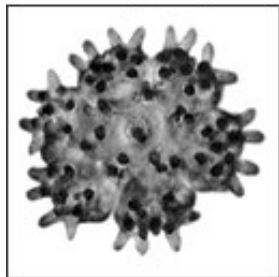

Figure 1

imagingu.com/articles/binning.html

Creation of a Digital Image

Analog Image



(a)

Digital Sampling

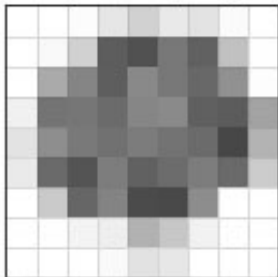

(b)

Pixel Quantization

249	244	240	230	209	233	227	251	255
248	245	210	93	81	120	97	193	254
250	170	133	94	137	120	104	145	253
241	116	118	107	134	138	96	92	163
277	142	121	113	124	115	107	71	179
234	106	84	125	97	108	125	106	204
241	202	102	132	75	73	141	246	252
253	252	244	239	178	199	242	250	245
255	249	244	250	226	231	240	251	253

(c)

Figure 1

imagingu.com/articles/digitalimagebasics.html

Complementary Metal Oxide Semiconductor (CMOS) Detectors

CMOS and CCD Pixels

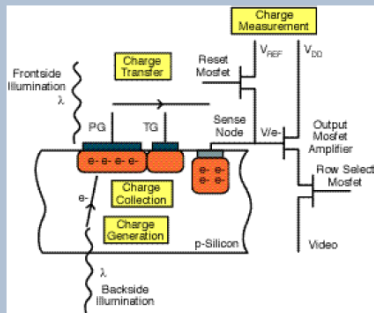

FIGURE 1 A cross-section of a CMOS pixel shows the four major functions required to generate an image.

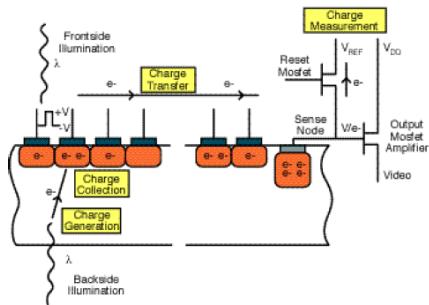
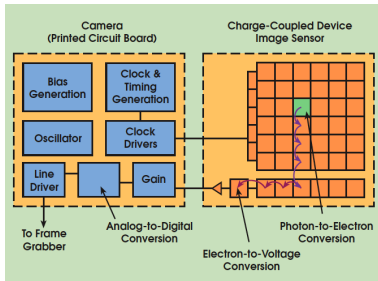
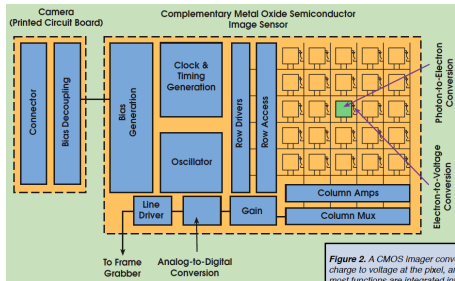

FIGURE 2 A cross-section of a CCD pixel shows the four major functions required to generate an image.

www.dalsa.com/shared/content/OE_Magazine_Dueling_Detectors_Janesick.pdf

CMOS and CCD Cameras



www.dalsa.com/shared/content/Photonics_Spectra_CCDvsCMOS_Litwiller.pdf

CMOS vs. CCD

- CMOS advantages over CCD:
 - standard semiconductor processing
 - low power consumption ($\approx 1\%$ of CCD)
 - random access to regions of interest
 - blooming and streaking much reduced compared to CCDs
 - additional electronics can be integrated on chip and in pixel (smart sensor)
 - non-destructive readout
- CMOS disadvantages:
 - small geometric fill factor (microlenses can help)
 - typically larger read noise

CMOS Hybrid Detectors

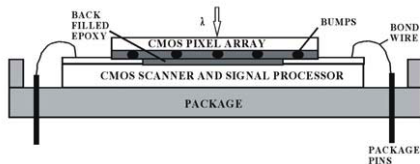

- combine CMOS readout multiplexer bonded to a photosensitive material layer pixel by pixel
- combines sensitivity of CCD with CMOS readout flexibility
- can also use HgCdTe or InSb for infrared sensitivity
- disadvantages:
 - expensive due to pixel-by-pixel bonding
 - differential thermal expansion of materials
 - image lag

Overview

- quantum efficiency
- bias
- dark current
- flat field

Quantum Efficiency

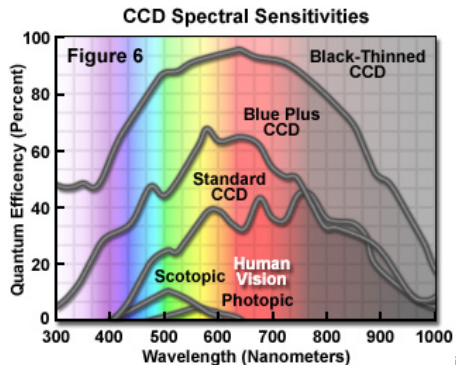

imagingu.com/articles/microscopyimaging.html

- quantum efficiency: conversion of photons \Rightarrow electrons
- absorption: avoid optically dead structures above or within pixel
- reflection: 70% loss at 250 nm without anti-reflective coating
- transmission: no photons generated in photosensitive volume (problem in near-infrared and soft X-rays)

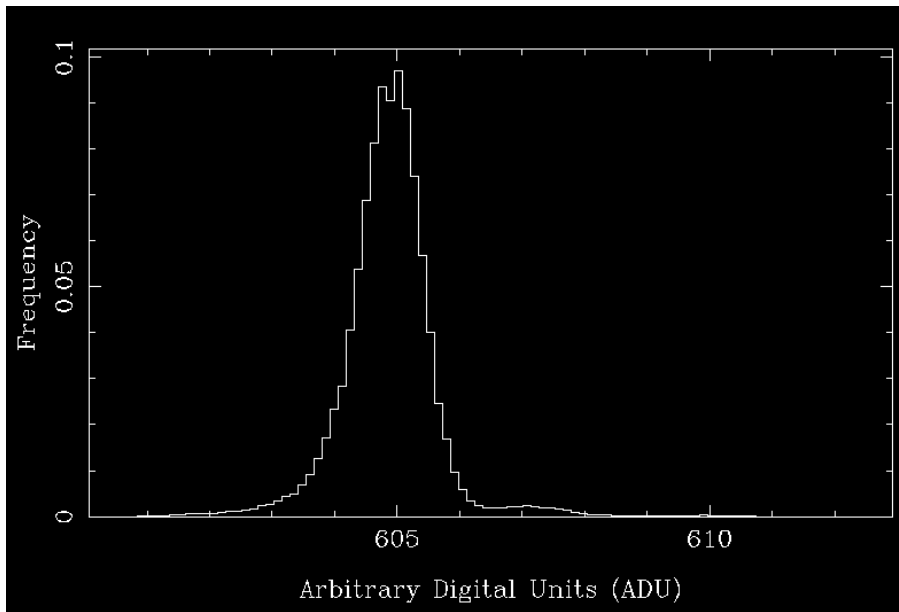

Dark Current

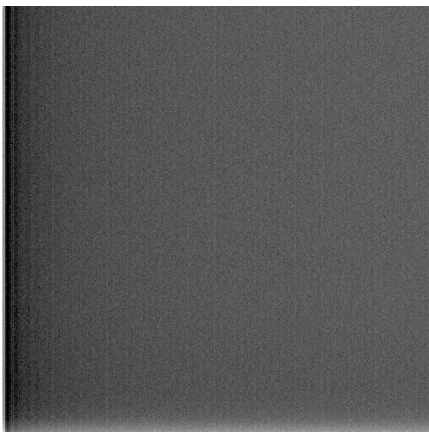

Dark Noise versus Temperature

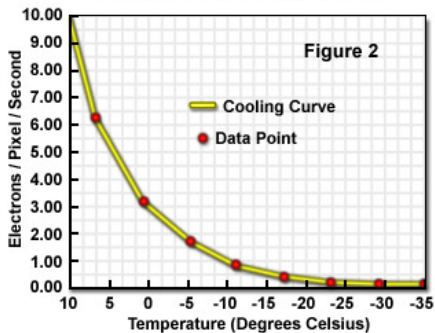

imagingu.com/articles/ccdsnr.html

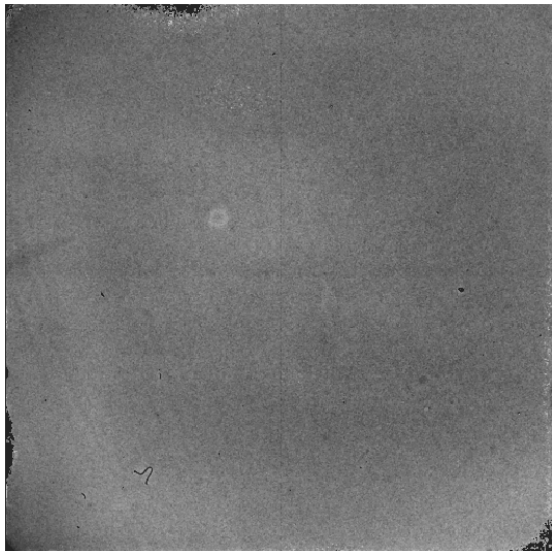

<http://www.not.iac.es/instruments/notcam/sci-grade-arr.html>

Array Detector Data Reduction

Raw Frame

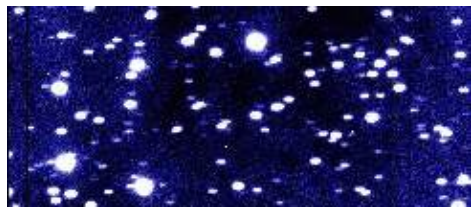

Bias + Dark

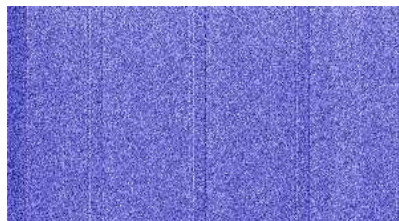

Reduced Frame

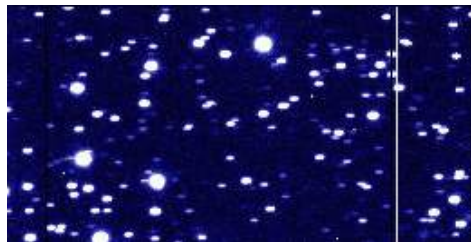

Flat Field

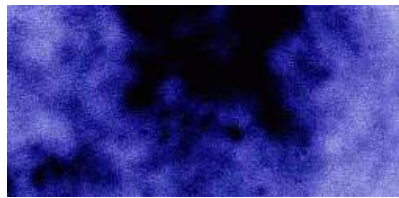

Typical Array Detector Data Reduction

- science frame S , exposure time t_S
- dark frame D , exposure time t_D
- bias frame B , zero exposure time
- flat field frame F , exposure time t_F
- corrected (calibrated) image

$$S' = \frac{S - \frac{t_S}{t_D}(D - B) - B}{F - \frac{t_F}{t_D}(D - B) - B}$$

- $F - \frac{t_F}{t_D}(D - B) - B$ often normalized such that mean of $S' =$ mean of S

Gain, Read Noise, Saturation Determination

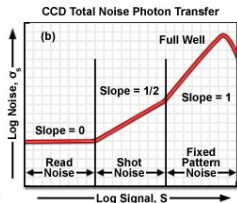
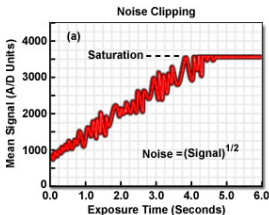
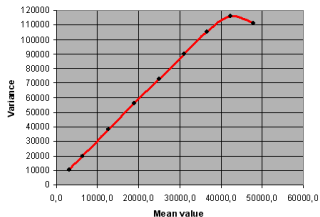

Figure 2

- gain (G) between arbitrary digital units (ADU, A) and number of photo-electrons (e): $A = G \cdot e$
- noise in e is given by $\sigma_e^2 = e$
- and therefore $\sigma_A^2 = G^2 \sigma_e^2 = G^2 e$
- gain G determined from $G = \frac{\sigma_A^2}{A}$

Array Detector Problems: Read Noise

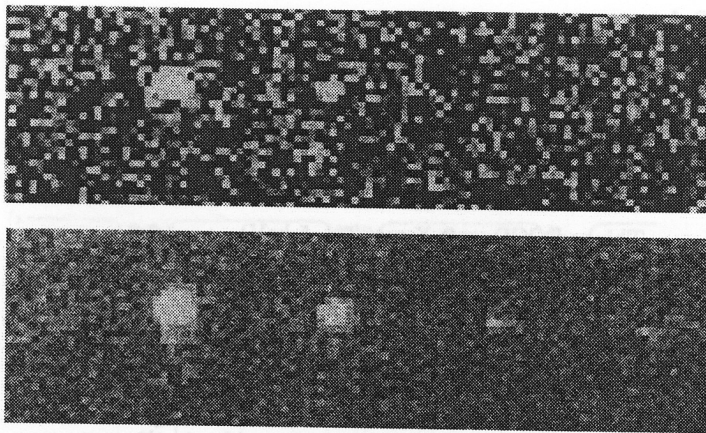
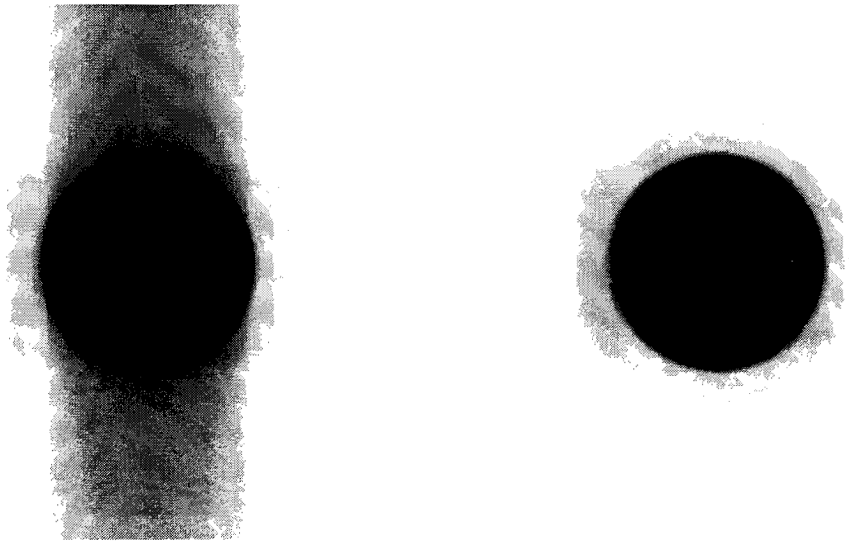

Fig. 7.28. (a) Image of four source points, by a CCD with $\sigma_R = 7.6 e^-$ rms. (b) The same image in multiple readout ($N = 64$), where $\sigma_R = 0.97 e^-$ rms. The faintest source corresponds to a signal of 3.5 photocharges. (After Janesik et al., in *The CCD in Astronomy*, ASP Conf. Ser. 8, 1989)

Array Detector Problems: Bias Shift



Array Detector Problems: Cross Talk



Figure 2: (left) Image similar to Figure 1 except shown in positive contrast and a range from 0 to 0.005 of the maximum illumination level. (center) Detail of left image channel 4 exposed at low light level. (right) Detail of channel 4 exposed at high light level.

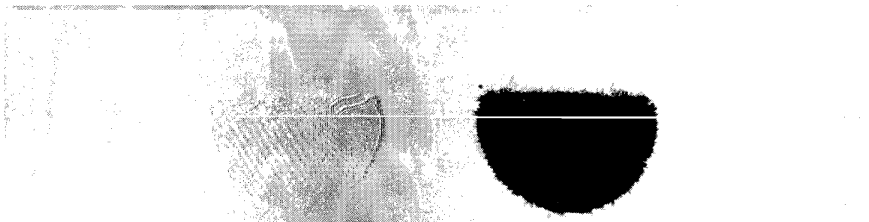
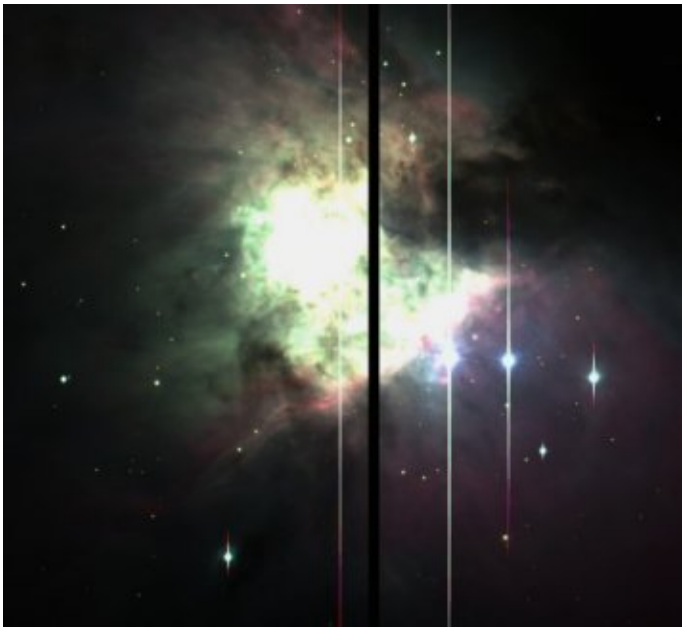
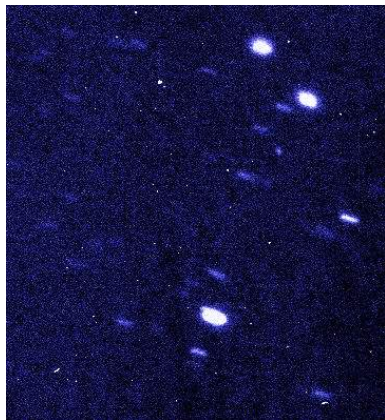

Figure 5: Negative contrast display of cross talk among four quadrants of a Rockwell Scientific Company HyViSI-1024 camera. The

Array Detector Problems: Blooming



Cosmic Rays



www.sc.eso.org/~ghainaut/ccd/CCD_artifacts.html

Array Detector Problems: Fringes

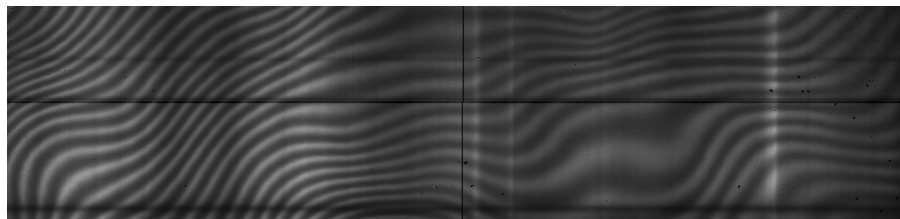

Other Array Detector Problems

- photon (shot) noise
- dark current noise; dark current is reduced by factor of 2 for every 7 K of cooling
- non-linearity of electronic amplification
- image lag