

Outline

- 1 Temporal and Spatial Modulation
- 2 Rotating Waveplate Polarimeters
- 3 Liquid Crystal Polarimeters
- 4 Spectral Modulation Polarimeters

General Polarimeters

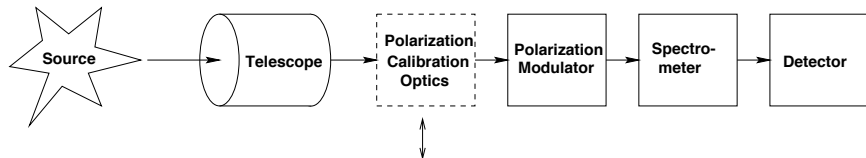

- polarimeters: optical elements (e.g. retarders, polarizers) that change polarization state of incoming light in controlled way
- detectors always measure only intensities
- intensity measurements combined to retrieve polarization state of incoming light
- polarimeters vary by polarization modulation scheme
- polarimeter should also include polarization calibration optics

Spatial Polarization Modulation

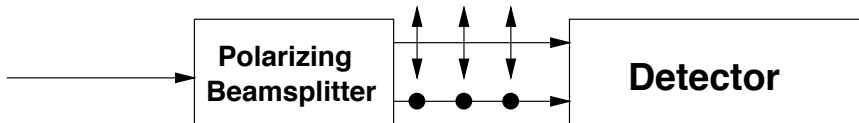

- polarizing beam-splitter polarimeter
- simple linear polarimeter: polarizing beam-splitter producing 2 beams corresponding to 2 orthogonal linear polarization states
- full linear polarization information from rotating assembly
- *spatial modulation*: simultaneous measurements of two (or more) Stokes parameters

Temporal Polarization Modulation

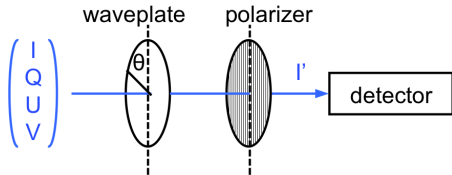

- rotating waveplate polarimeter
- rotating retarder, fixed linear polarizer
- measured intensity as function of retardance δ , position angle θ

$$I' = \frac{1}{2} \left(I + \frac{Q}{2} ((1 + \cos \delta) + (1 - \cos \delta) \cos 4\theta) + \frac{U}{2} (1 - \cos \delta) \sin 4\theta - V \sin \delta \sin 2\theta \right)$$

- only terms in θ lead to modulated signal
- equal modulation amplitudes in Q , U , and V for $\delta=127^\circ$
- *temporal modulation*: sequential measurements of $I \pm$ one or more Stokes parameters

Comparison of Temporal and Spatial Modulation Schemes

Modulation	Advantages	Disadvantages
temporal	negligible effects of flat field and optical aberrations potentially high polarimetric sensitivity	influence of seeing if modulation is slow limited read-out rate of array detectors
spatial	off-the-shelf array detectors high photon collection efficiency allows post-facto reconstruction	requires up to four times larger sensor influence of flat field influence of differential aberrations

schemes rather complementary \Rightarrow modern, sensitive polarimeters use both to combine advantages and minimize disadvantages

Fundamentals

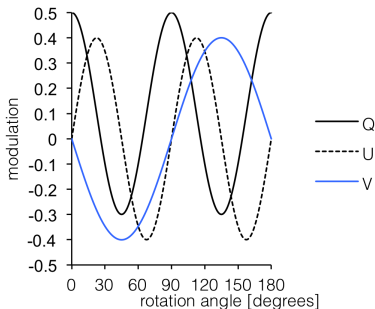

$$I' = \frac{1}{2} \left(I + \frac{Q}{2} ((1 + \cos \delta) + (1 - \cos \delta) \cos 4\theta) + \frac{U}{2} (1 - \cos \delta) \sin 4\theta - V \sin \delta \sin 2\theta \right)$$

- Q , U modulated at twice the frequency of V
- phase shift in modulation between Q and U is $90^\circ \Rightarrow$ measurements at 8 angles to determine all 4 Stokes parameters

Double-Ratio Technique

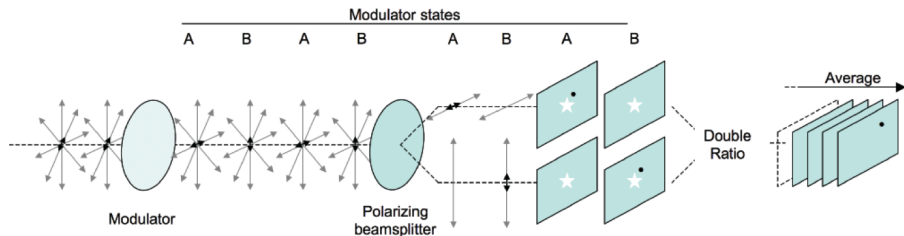

- combination of spatial and temporal modulation
- rotating waveplate, polarizing beamsplitter
- waveplate switches between orthogonal polarization states
- both beams are recorded simultaneously
- 4 measurements to estimate Stokes Q/I largely free of effects from seeing and gain variations between different detector areas

Double-Ratio Technique (continued)

- measured intensities in two beams in first exposure

$$S_1^l = g_l \alpha_1 (I_1 + Q_1), \quad S_1^r = g_r \alpha_1 (I_1 - Q_1)$$

- subscript 1: first exposure
 - subscripts l, r : left, right beams
 - S : measured signal
 - g : gain in particular beam
 - α : transmission of atmosphere, instrument
- second exposure

$$S_2^l = g_l \alpha_2 (I_2 - Q_2), \quad S_2^r = g_r \alpha_2 (I_2 + Q_2)$$

- incoming I and Q in second exposure may be completely different from first exposure
- also includes beam-wobble induced by rotation of wave plate

Double-Ratio Technique (continued)

- combination of 4 measured intensities removes effect of transmission changes and differential gain variations of different detector areas

$$\frac{1}{4} \left(\frac{S_1^l S_2^r}{S_2^l S_1^r} - 1 \right) = \frac{1}{2} \frac{I_2 Q_1 + I_1 Q_2}{I_1 I_2 - I_2 Q_1 - I_1 Q_2 + Q_1 Q_2}$$

- if $Q \ll I$

$$\frac{1}{2} \left(\frac{Q_1}{I_1} + \frac{Q_2}{I_2} \right)$$

- obtain average V/I signal of two exposures
- no spurious polarization signals are introduced
- double-difference can achieve similar results

left beam

right beam

FLC state A

FLC state B



FLC states (A-B)

left beam

right beam

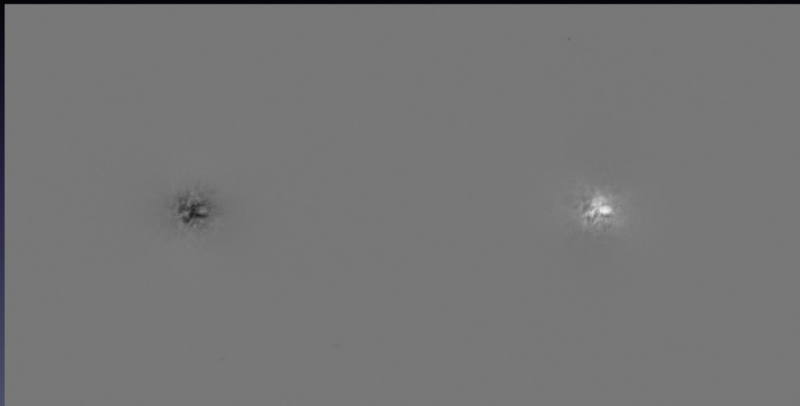

$$(A-B)_{\text{left}} - (A-B)_{\text{right}}$$

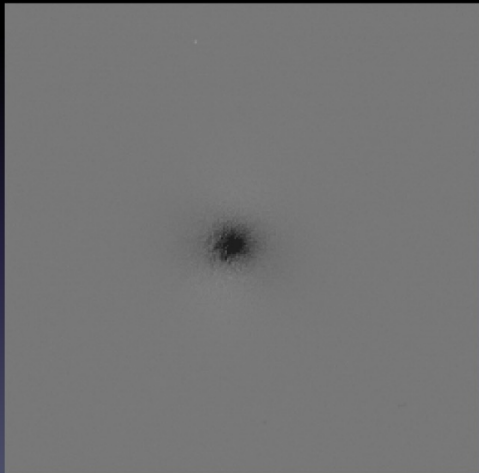

+ 0.7% * intensity

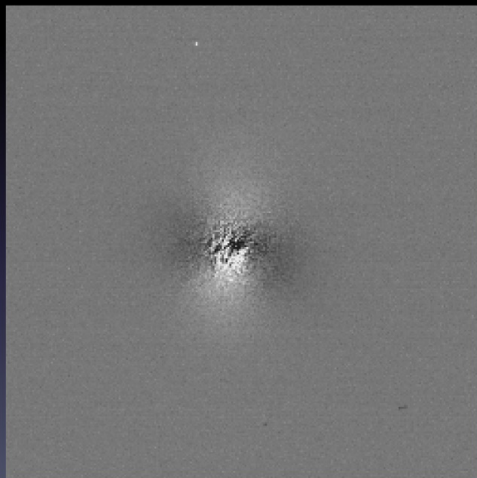

Division by Intensity

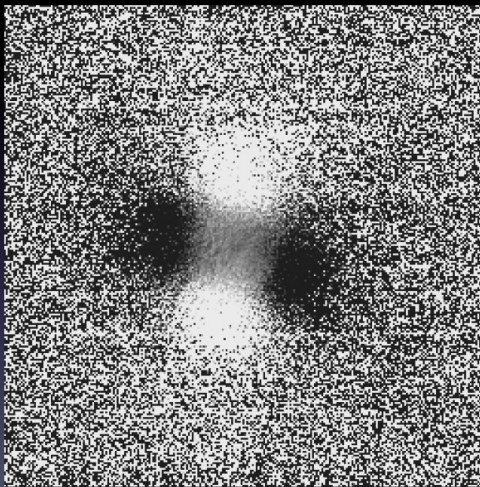

Introduction

- HARPS: Most successful exoplanet finder
- measure magnetic fields of planet-hosting stars
- only publicly accessible high-resolution spectropolarimeter in the southern hemisphere

Requirements

- Use slider and volume of Iodine cell
- Do not compromise performance and operations of HARPS
- Full Stokes
- Polarimetric sensitivity 10^{-4} for one night on a bright star
- 380-690 nm
- Minimal instrumental polarization
- Minimal (polarized) fringes

optical design

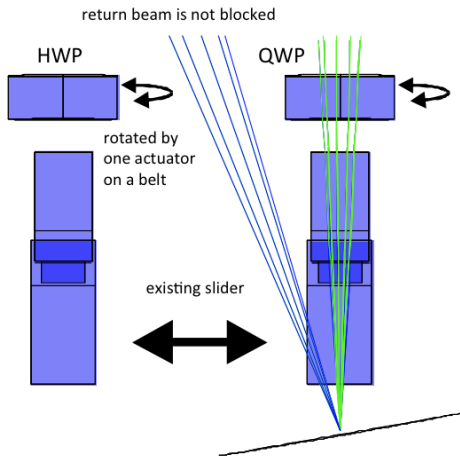
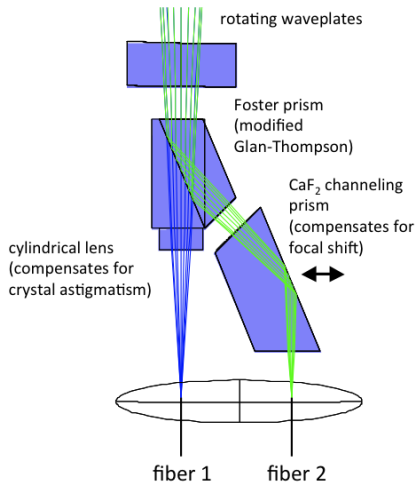

mechanical design

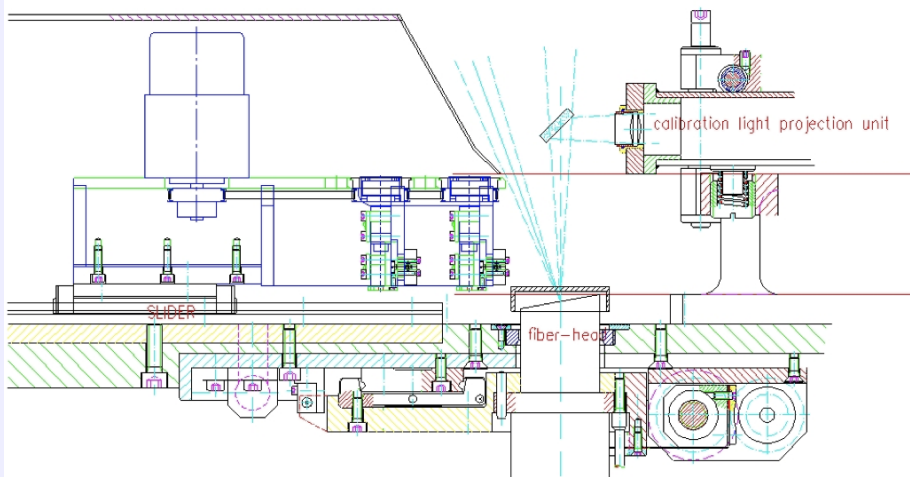

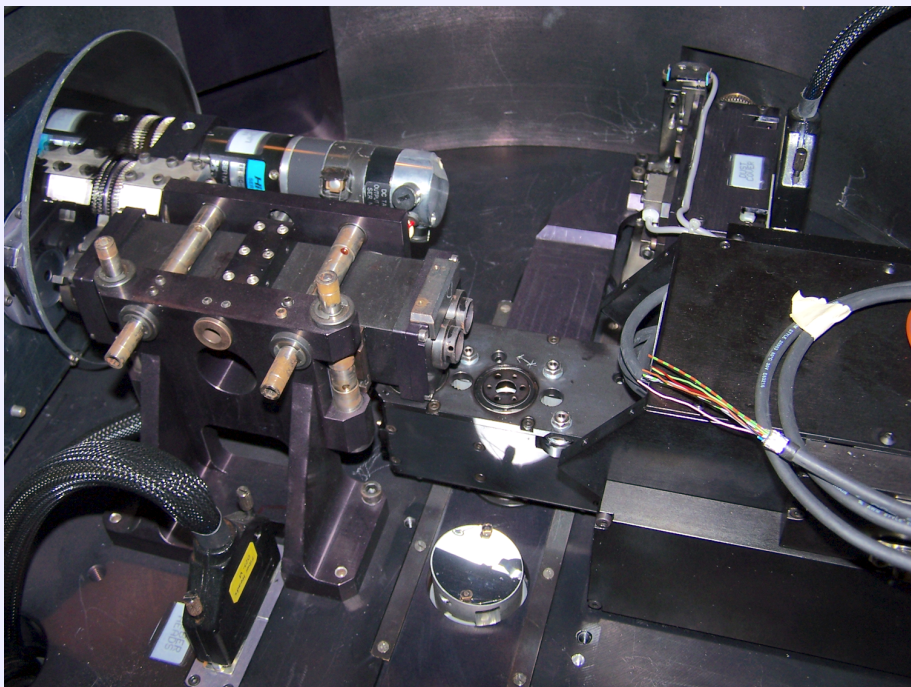

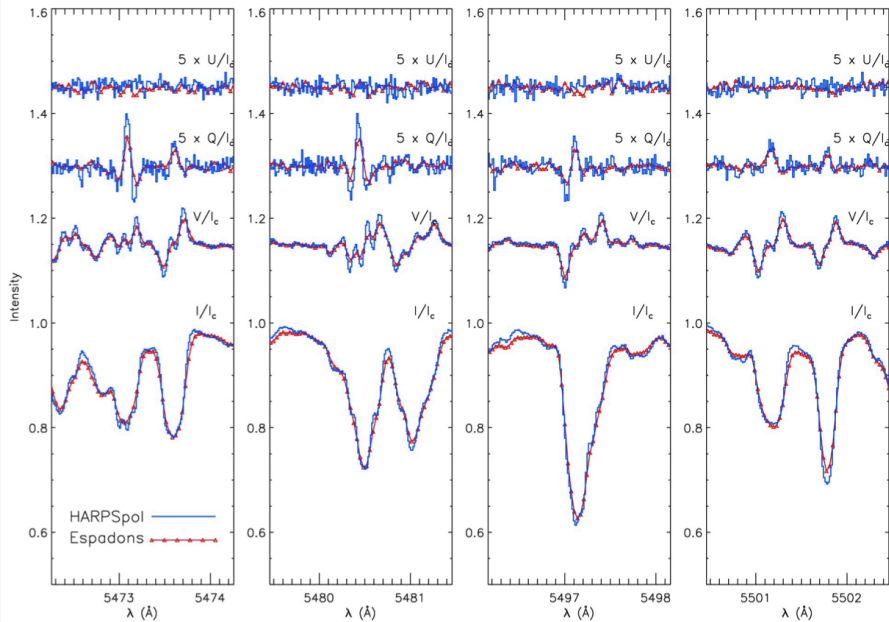

Introduction

- no moving parts
- nematic liquid crystals
 - change retardance with applied electric field
 - relatively slow (<50 Hz)
 - electrically tunable for different wavelengths
- ferro-electric liquid crystals
 - flip fast axis orientation with applied electric field (2 states only)
 - fast (<10 kHz)
 - fixed retardation and optimum wavelength
- often combinations of variable liquid crystal retarders and fixed retarders

Extreme Polarimeter (ExPo)

- imaging polarimetry testbed at 4.2-m William Herschel Telescope
- 500-900nm dual-beam, FLC
- EM-CCD, <35 frames/s, $<1e^-$ RON
- sCMOS, 50 frames/s, $\sim 1e^-$ RON
- 97-actuator Adaptive Optics

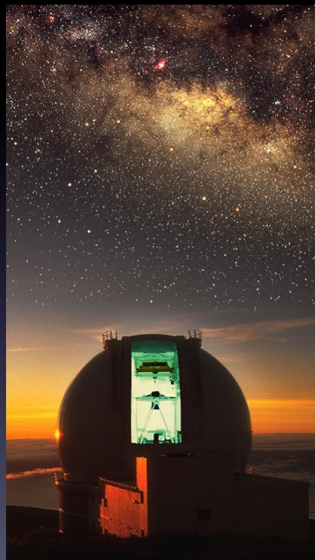

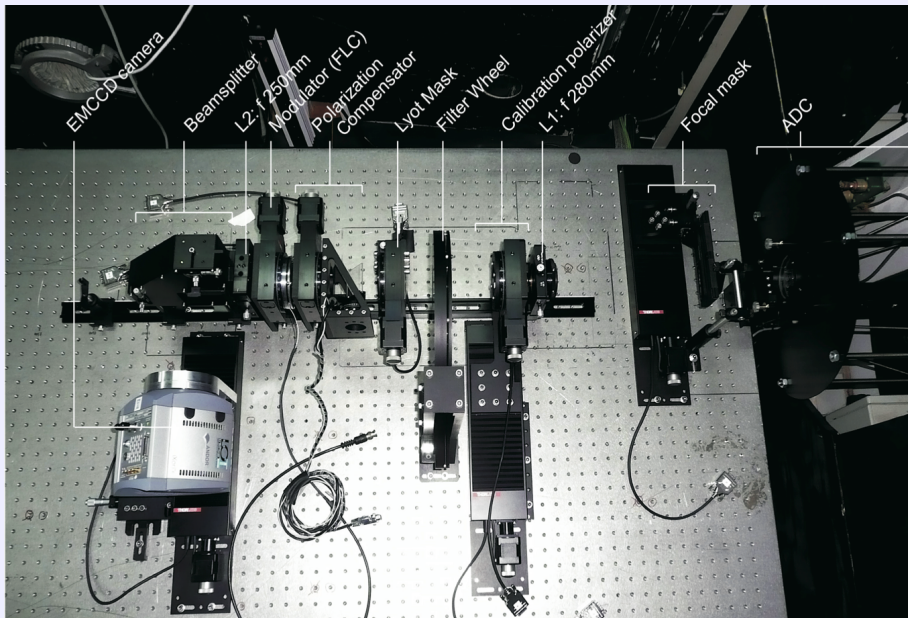

Contrast

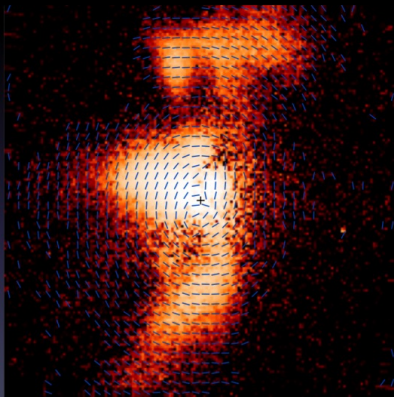

T-Tauri

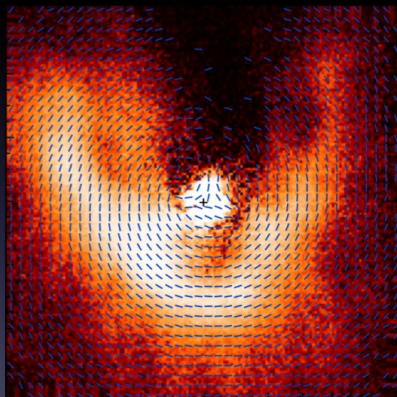

MWC147

Confirmation (R Coronae Borealis)

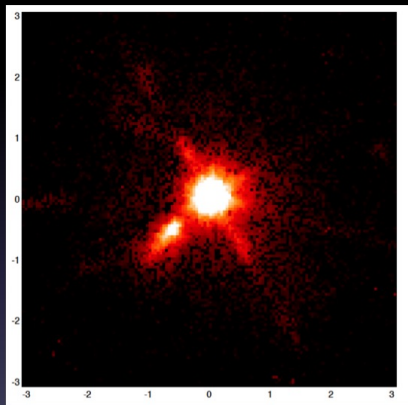

Intensity (HST)

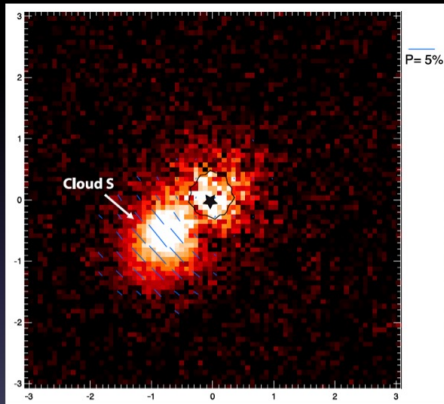

Linear Polarization (WHT)
(Jeffers et al. 2012)

Characterization

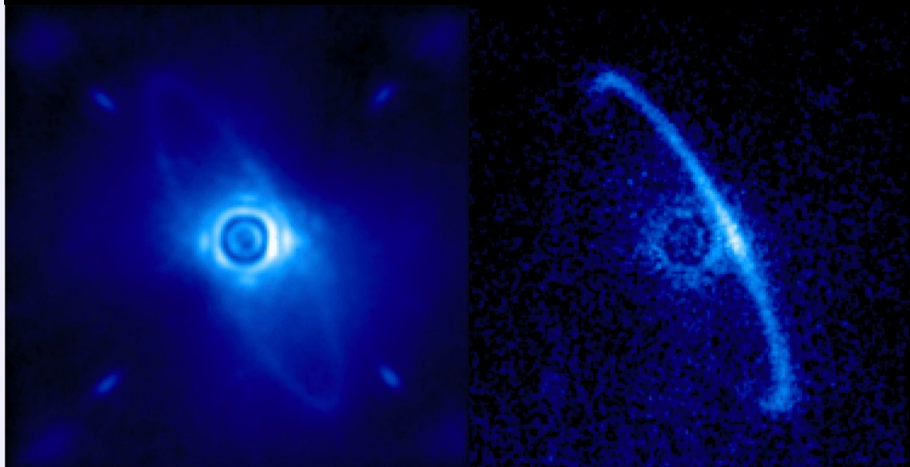

GPI First Light HR_{4796A} (Image credit: Processing by Marshall Perrin, STScI)

Interleaved, Polarized Spectra

(0th & +/-1 order indicated)

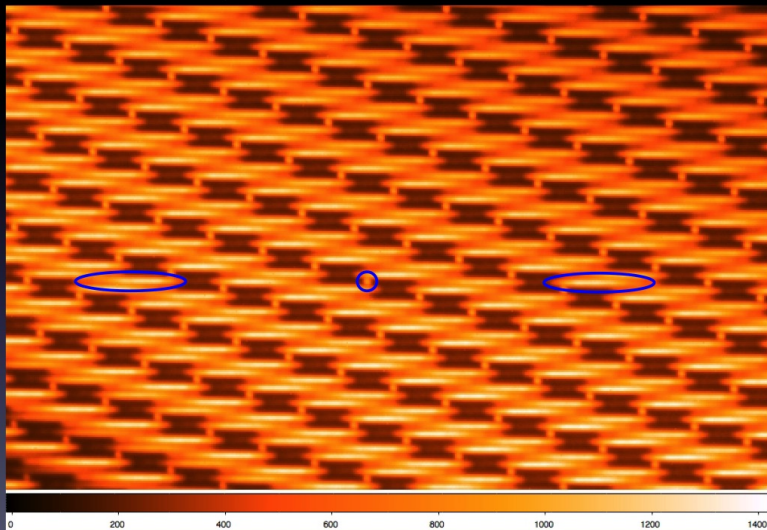

SOLIS Vector-Spectromagnetograph (VSM)



Specifications

Parameter	Specification
Effective pixel size	1 arcsec by 1 arcsec (1.125 by 1.125 arcsec initially)
Angular coverage	2048 arcsec by 2048 arcsec
Geometric accuracy	0.5 arcsec rms after data reduction
Scan rate	0.2 to 5.0 seconds/arcsec
Timing accuracy	Better than 1 second
Time stamping	Better than 1 ms
Spectral resolution	238,000 (at 630 nm)
Wavelengths	630 nm, 854 nm, 1083 nm
Polarimetry	<ul style="list-style-type: none">• FeI 630.15 and FeI 630.25 nm: I,V,Q,U• Call 854 nm: I,V• HeI 1083.0 nm: I
Polarimetric sensitivity	0.0002 at 0.5 seconds/arcsec scanning rate
Polarimetric accuracy	Better than 0.001

Technical Challenges

Challenge	Solution
Compact instrument no longer than 2.5 m	Folded f/6.6 beam
Good and stable spatial resolution	Helium-filled, active M2
High guiding accuracy of better than 0.5 arcsec rms	Guider in slit plane, active secondary mirror
Low instrumental polarization of less than $1 \cdot 10^{-3}$	Axially symmetric design
Fixed image size, low distortion from 630 to 1090 nm	Quasi RC with correctors
Stable high spectral resolution of 200,000	Large, active grating
Highest possible throughput	Silver, multilayer coatings, CMOS hybrid cameras
Energy densities of up to 0.2 MW/m ²	Copper-silicon carbide plate
High data rate of up to 320 Mbyte/s	DSP array, Storage Area Network

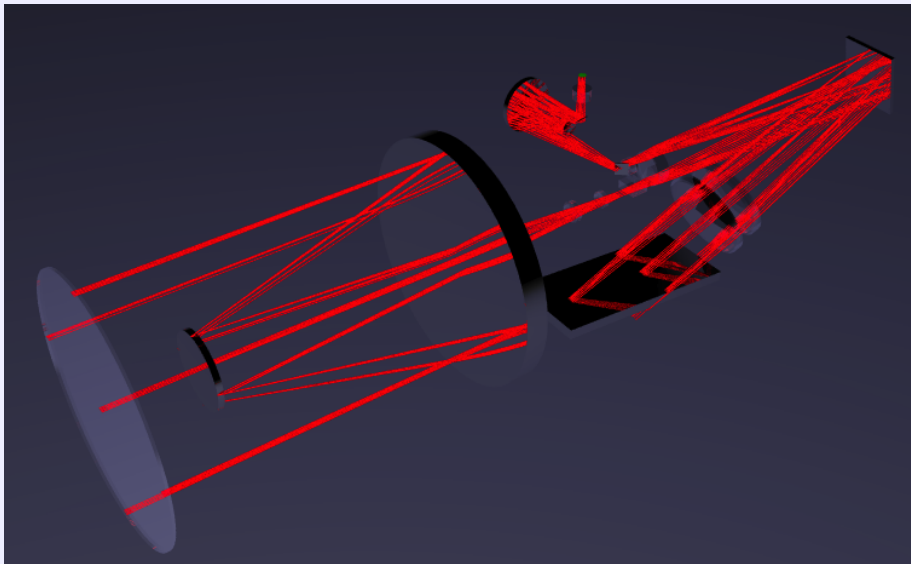

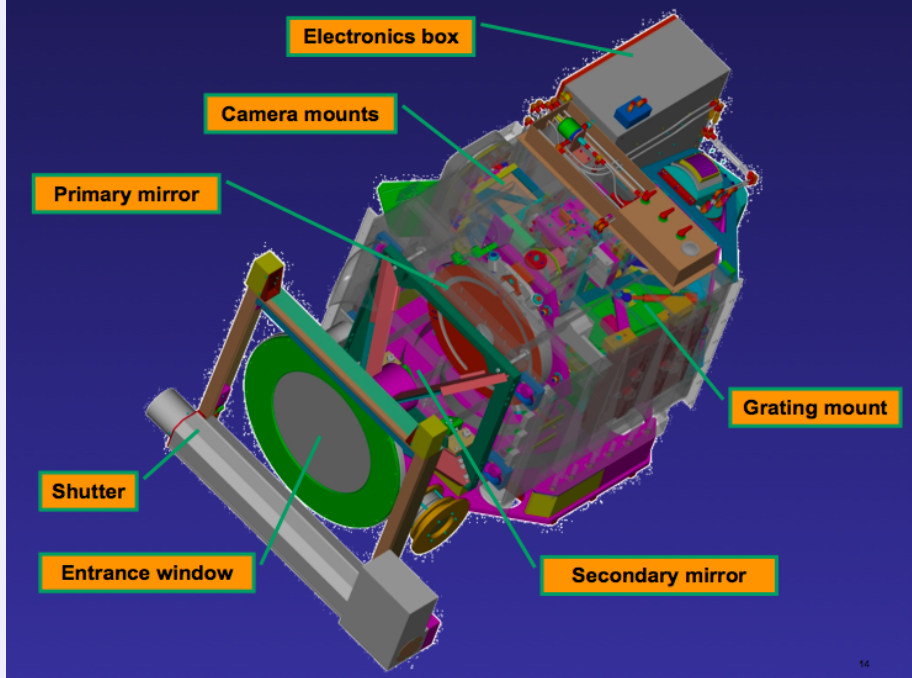

Telescope

- Helium-filled f/6.6 Ritchey-Chrétien with field corrector lenses
- Entrance window provides environmental protection
 - 6-mm thick oversized, fused silica to minimize edge effects
 - 'Floats' in RTV to minimize stress birefringence

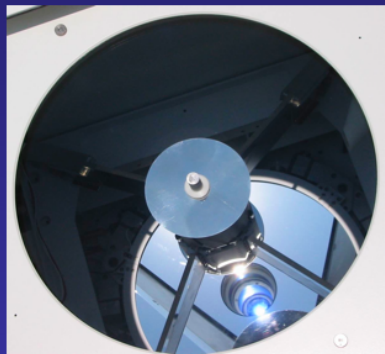
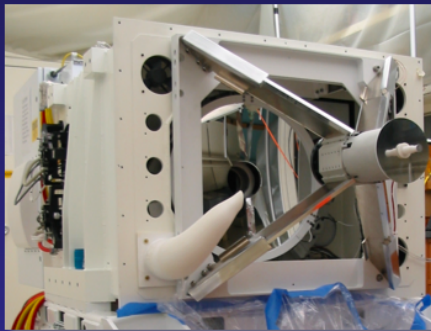

- 575-mm f/1.4 ULE primary mirror
- Single crystal silicon secondary
 - 40 Hz tip/tilt closed-loop bandwidth piezo platform
 - Slow closed-loop focus control
 - Cooled by helium flow

Folded Littrow Spectrograph

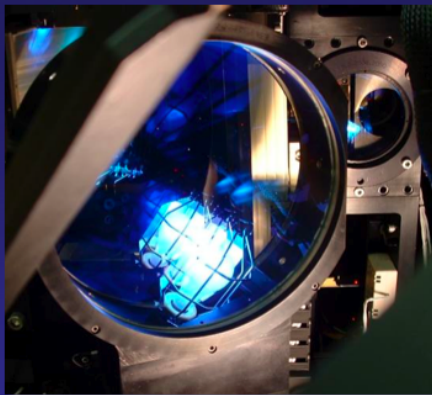

Littrow lens

- Air-spaced doublet
- Athermal design
- Moves to adjust for different wavelengths
- Dual Offner reimaging optics

Grating

- 79 lines/mm on 204 mm by 408 mm fused silica blank
- Almost no instrumental polarization
- Rotates for different wavelengths
- Active adjustment in 2 axes to compensate for flexure

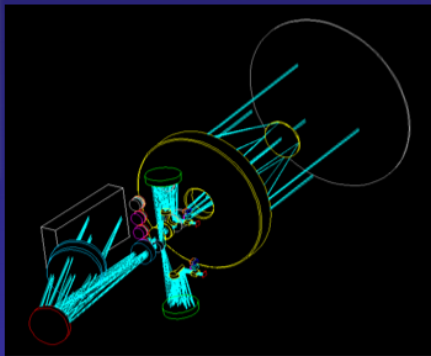

Polarization Calibration

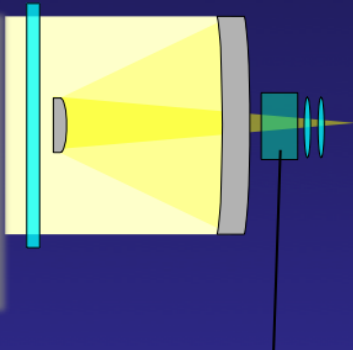

- 'Polarization-free' optics before polarization calibration
- Polarization calibration occurs as early as possible
- interference filters to limit solar flux
- rotating polarizers and retarders at 630 nm, fixed at 854 nm

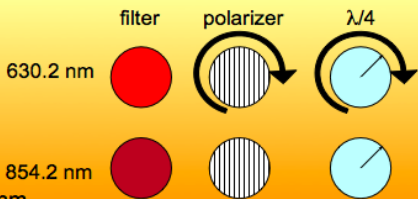

Polarization Modulation

- Ferroelectric liquid crystal (FLC) variable retarders (all $\lambda/2$ at 630 nm)
- Fixed $\lambda/4$ (at 630 nm) and $\lambda/6$ (at 854 nm) polymer retarders
- All true zero-order retarders to cope with fast f/6.6 beam
- Full vector modulation similar to Gandorfer and Rabin schemes
- Exact position angles optimized based on measured FLC properties
- After modulation, both polarization states pass the same low-polarization optics
- Solar-B spectropolarimeter and Diffraction-Limited Spectro-Polarimeter (DLSP) at Dunn Solar Telescope are based on VSM concept

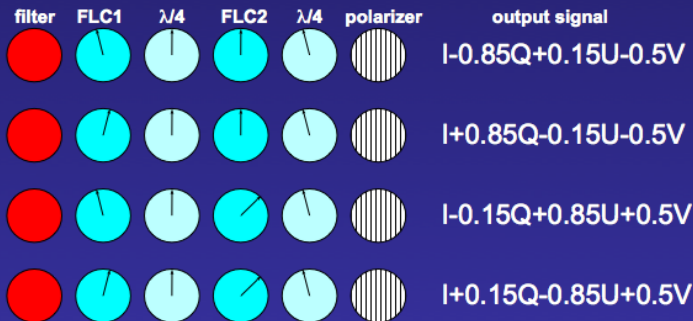

Polarization Analysis

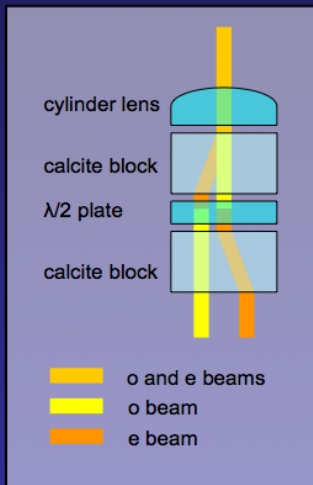

- Modified Savart plate
- Crystal astigmatism is a major issue for an $f/6.6$ beam, corrected by cylinder lens
- Provides high quality polarizing beam-splitting for fast beam and large field of view
- Different beamsplitters for 630.2 nm and 854.2 nm
 - Calcite splitting is wavelength dependent
 - Can use simple mica retarder

Separation of Polarization Modulation and Polarizer

- FLC and retarders located behind spectrograph entrance slit
- polarizing beamsplitters located in front of cameras
- spectrograph and associated optics built to minimize instrumental polarization between modulators and polarizing beam splitters
- advantages of VSM approach: no moving parts for polarization analysis, switching of polarization states can occur rapidly, and both polarization states are detected simultaneously after having passed through the same optics

CCD Operating Principle

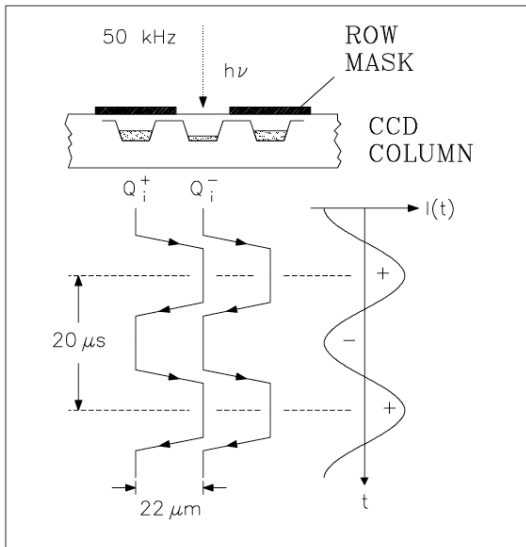

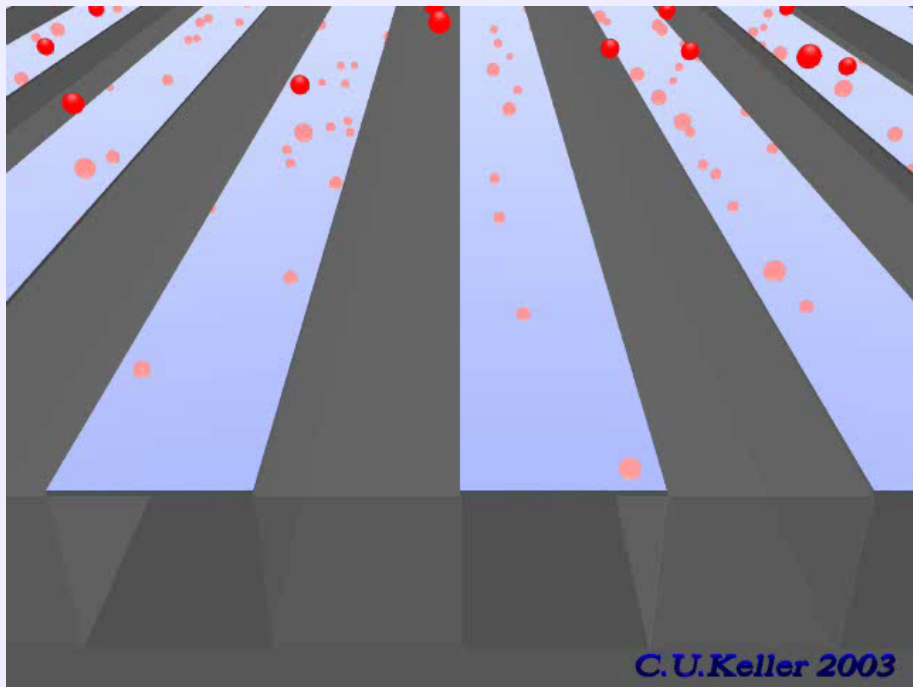

C. U. Keller 2003

CCD Array as Fast Demodulator

- ZIMPOL I polarization modulator consists of a polarization modulators and a polarizer or polarizing beamsplitter
- developed at ETH Zurich by H.P.Povel and coworkers about 25 years ago
- center piece of SPHERE/ZIMPOL at VLT
- fractional polarization free of flat-field effects
- no seeing effects due to high modulation frequency

Scattering Polarization

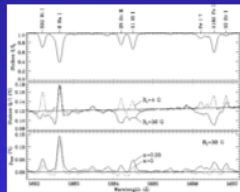
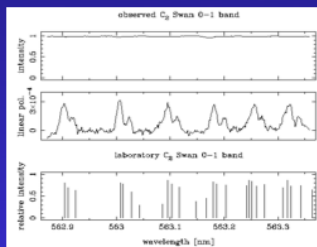
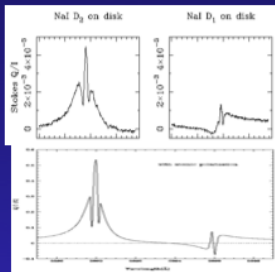
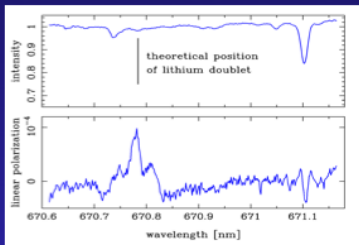

Scattering Polarization Atlas

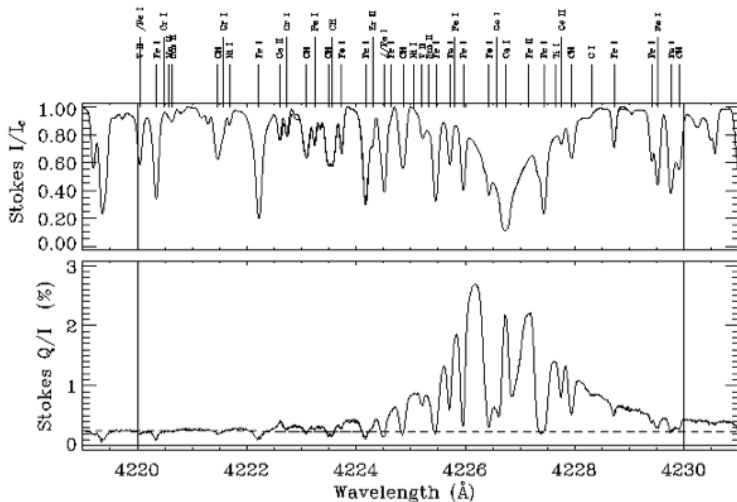

Courtesy Achim Gandorfer

Introduction

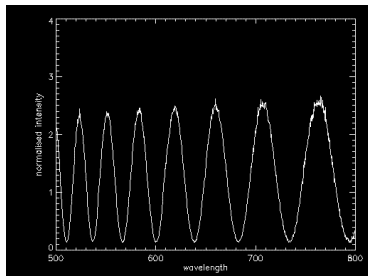
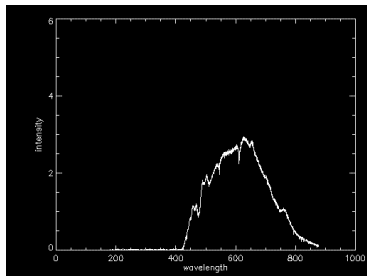

- modulation amplitude: degree of linear polarization ($\sqrt{Q^2 + U^2}/I$)
- modulation phase = orientation of linear polarization ($\arctan Q/U$)
- Passive (no electricity, mechanical motion)
- One-shot measurement
- No differential effects, low susceptibility to noise

SPEX polarimetry

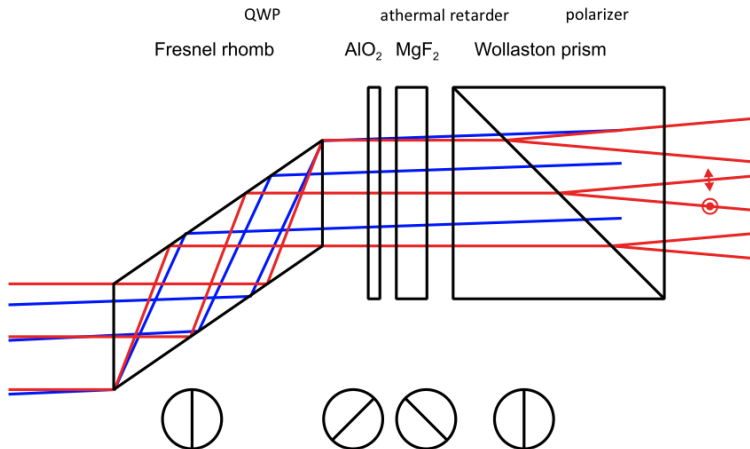

$$I(\lambda) = \frac{1}{2} I_0(\lambda) \left[1 \pm P_L(\lambda) \cos \left(\frac{2\pi \cdot \delta(\lambda)}{\lambda} + 2\varphi_L(\lambda) \right) \right]$$

Snik & Keller (2008) preliminary patent

SPEX: Spectropolarimeter for Planetary EXploration

- Measure size distribution and composition of planetary atmospheres
- dust (storms) on Mars, atmosphere of Jupiter, aerosols in Earth atmosphere
- needs to cover large wavelength range
- SPEX airborne on NASA ER-2
- flySPEX demonstrator
- LOUPE to study Earth as an exoplanet from the moon
- NASA PACE satellite considering SPEX
- iSPEX citizen science

SPEX specs

Wavelength range	400-800 nm
Observables	Stokes I, Q, U (=intensity + DoLP + AoLP)
Polarimetric sensitivity	DoLP=0.005
Polarimetric accuracy	5% relative down to 0.01 absolute
Intensity spectral resolution	2 nm
Polarization spectral resolution	20 nm
Viewing directions	7 + 2 limb viewers
FOV per viewing direction	7 degrees (across track, swath width) x 1.7 degrees (along track)
Maximum mass	2 kg
Dimensions of SPEX spectropolarimeter subsystem	190 x 100 x 60 mm ³
Maximum power consumption	2 W
Temperature requirement	Close to room temperature
Data rate requirement	0.5 Gbit/day (Mars to Earth datarate)

SPEX optical design

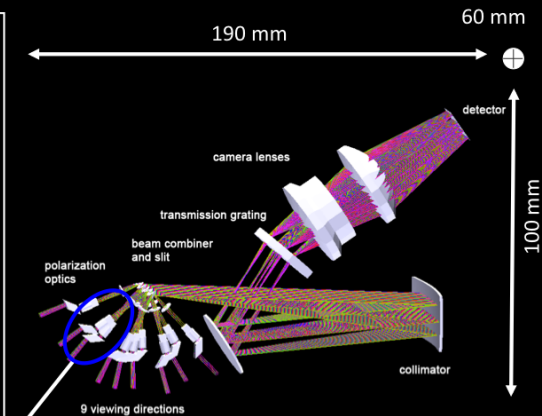
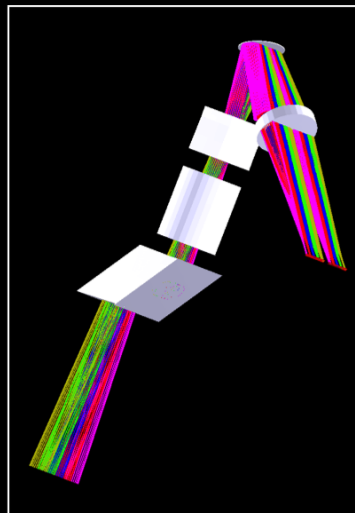

SPEX breadboard

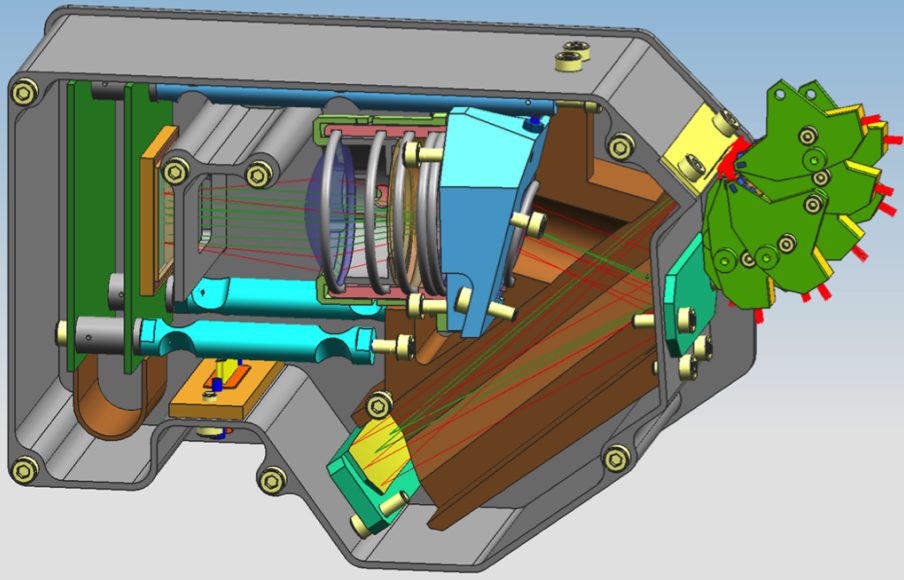

Polarimetric performance

